

Trinkwassererwärmer YADO/ AQUA DL-PR SWM

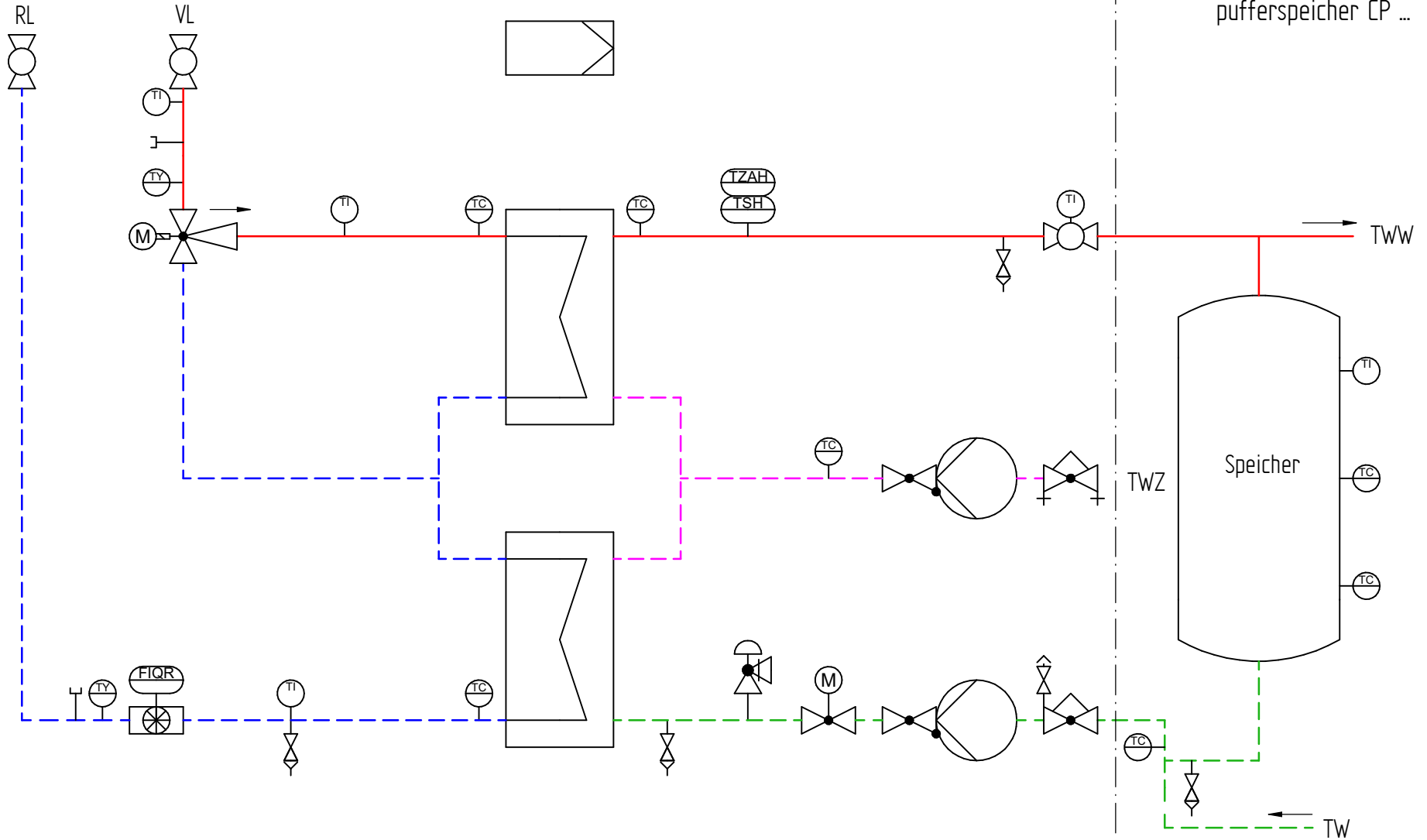







Trinkwarmwasser-
pufferspeicher CP ...

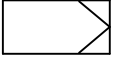
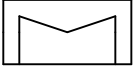















Dargestellte R&I-Symbole des Fließschemas können auch ein Passstück sein. Welche Bauteile Bestandteil des Produktes bzw. Systems sind, steht in der Stückliste der Leistungsbeschreibung.

		Maßstab :		Material:	
		Masse:		Werkstoff:	
Schutzvermerk nach ISO 16016 beachten Mit der Entgegennahme dieser Zeichnung verpflichtet sich der Empfänger, sie vertraulich zu behandeln. Er darf sie nur zur Ausführung des ihm erteilten Auftrages benutzen, insbesondere also nicht ohne vorherige schriftliche Zustimmung vervielfältigen, Dritten zugänglich machen oder in anderer Weise verwenden. Bei Zuwiderhandlungen haftet uns der Empfänger für alle Schäden.		Name		Datum	
Ersteller		Bednarz, C.		29.10.2015	
Bearb.					
Zeichnungs-Nr.		Material-Nr.		A3	
01		8006333		20.12.2021	
		Blatt 1/1			

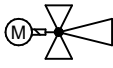
Titel: Trinkwassererwärmer YADO/AQUA DL-PR SWM
50KW DN25/25/20 PN25/10 140/80°C
Climatix®

Symbol	Bezeichnung
	DDC - Regler
	Wärmeübertrager
	Temperatursensor
	Temperatursensor für Wärmezähler
	Wärmezähler
	Thermometer
	Temperaturregler/ Sicherheits- temperaturwächter (max)
	Stutzen Rp (Rohrgewinde innen) mit Stopfen
	Volumenstrombegrenzer

Symbol	Bezeichnung
	Kugelhahn mit Thermometer
	Kugelhahn
	Entleerung
	Entlüftung
	Pumpe
	Rückschlagventil
	Pufferspeicher
	Volumenstrombegrenzer mit Messnippel

Symbol	Bezeichnung
	Durchgangsventil mit Antrieb ohne Sicherheitsfunktion
	Strahlpumpe mit Antrieb mit Sicherheitsfunktion
	Membran Sicherheitsventil
	Rücklauf
	Trinkwasser
	Trinkwarmwasser
	Trinkwasser Zirkulation
	Vorlauf