

YADO|SHARE

für effiziente Wärmeverteilung.

Einfach
Schnell
Präzise

Anleitung Anfrageformular



YADOS
Energie mit Zukunft

YADO|SHARE Anfrageformular

Standarddesign.

Anlage

Objektadresse _____

Kunde _____

Referenz _____

Außendienst _____

Datum _____

Heizkreise und Einspeisung

Heizkreis Anzahl in Standarddesign	Direktlade- heizkreis DLK		Direkt- heizkreis DHK		Mischerheizkreis MHK					Mischerheizkreis dB (direkte Beimischung) MHK dB					Einspeisung
	1	2	1	2	1	2	3	4	5	1	2	3	4	5	
Basis	<input type="checkbox"/>	<input type="checkbox"/>	<input type="checkbox"/>	<input type="checkbox"/>	<input type="checkbox"/>	<input type="checkbox"/>	<input type="checkbox"/>	<input type="checkbox"/>	<input type="checkbox"/>	<input type="checkbox"/>	<input type="checkbox"/>	<input type="checkbox"/>	<input type="checkbox"/>	<input type="checkbox"/>	<input type="checkbox"/>
Comfort	<input type="checkbox"/>	<input type="checkbox"/>	<input type="checkbox"/>	<input type="checkbox"/>	<input type="checkbox"/>	<input type="checkbox"/>	<input type="checkbox"/>	<input type="checkbox"/>	<input type="checkbox"/>	<input type="checkbox"/>	<input type="checkbox"/>	<input type="checkbox"/>	<input type="checkbox"/>	<input type="checkbox"/>	<input type="checkbox"/>
Premium	<input type="checkbox"/>	<input type="checkbox"/>	<input type="checkbox"/>	<input type="checkbox"/>	<input type="checkbox"/>	<input type="checkbox"/>	<input type="checkbox"/>	<input type="checkbox"/>	<input type="checkbox"/>	<input type="checkbox"/>	<input type="checkbox"/>	<input type="checkbox"/>	<input type="checkbox"/>	<input type="checkbox"/>	<input type="checkbox"/>
Heizkreis	1	2	1	2	1	2	3	4	5	1	2	3	4	5	
Heizung															
• Radiator					<input type="checkbox"/>	<input type="checkbox"/>	<input type="checkbox"/>	<input type="checkbox"/>	<input type="checkbox"/>	<input type="checkbox"/>	<input type="checkbox"/>	<input type="checkbox"/>	<input type="checkbox"/>	<input type="checkbox"/>	<input type="checkbox"/>
• Fussbodenheizung					<input type="checkbox"/>	<input type="checkbox"/>	<input type="checkbox"/>	<input type="checkbox"/>	<input type="checkbox"/>	<input type="checkbox"/>	<input type="checkbox"/>	<input type="checkbox"/>	<input type="checkbox"/>	<input type="checkbox"/>	<input type="checkbox"/>
Leistung															
•	kW
Temperatur Heizkreis															
• Vorlauf	°C
• Rücklauf	°C
Pumpe Heizkreis															
• Druckverlust Hausanlage *	mbar
Wärmezähler ** (nur Premium)															
• Q _p	m ³ /h
• 230 V		<input type="checkbox"/>	<input type="checkbox"/>	<input type="checkbox"/>	<input type="checkbox"/>	<input type="checkbox"/>	<input type="checkbox"/>	<input type="checkbox"/>	<input type="checkbox"/>	<input type="checkbox"/>	<input type="checkbox"/>	<input type="checkbox"/>	<input type="checkbox"/>	<input type="checkbox"/>	<input type="checkbox"/>
• Batterie		<input type="checkbox"/>	<input type="checkbox"/>	<input type="checkbox"/>	<input type="checkbox"/>	<input type="checkbox"/>	<input type="checkbox"/>	<input type="checkbox"/>	<input type="checkbox"/>	<input type="checkbox"/>	<input type="checkbox"/>	<input type="checkbox"/>	<input type="checkbox"/>	<input type="checkbox"/>	<input type="checkbox"/>

* Sind keine Werte eingetragen, werden folgenden Defaultwerte verwendet:
 - Radiatorenheizung: 300 mbar
 - Fussbodenheizung 400 mbar
 - Zähler verbaut

Aufbau Heizungsverteiler YADO|SHARE



Heizkreise

Bitte Art und die Nummer des Heizkreises an der entsprechenden Position eintragen, z.B.

DHK	DHK	MHK	MHK dB
1	1	2	1

Reihenfolge der Heizkreise wird **bei Auftrag definiert**.



Einspeisung

Anschluss seitlich



oben



Position
links

rechts

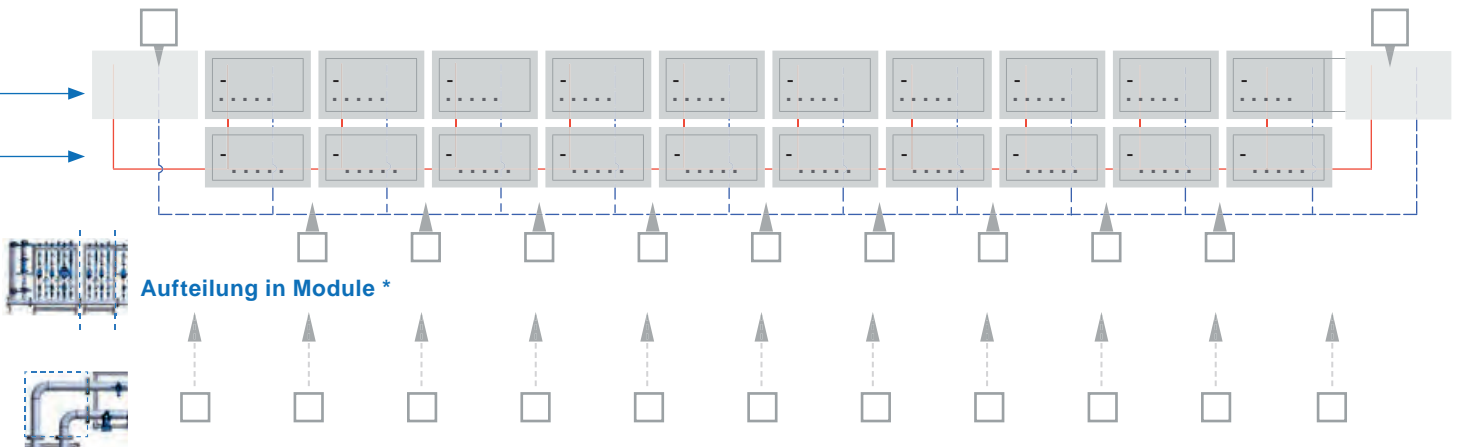

Position Eckmodul

Regelung

YADO MATIX (Standard)	<input type="checkbox"/>
Trovis 55	<input type="checkbox"/>
TopTronic® E	<input type="checkbox"/>

Schaltschrank

• ja / nein /

Verdrahtung

• ja / nein /

Dämmung

• EPP 50 % (Standard)	<input type="checkbox"/>
• EPP 100 %	<input type="checkbox"/>
• ohne	<input type="checkbox"/>

Lieferung

• geteilte Anlieferung (Module)	<input type="checkbox"/>
• kompletter Verteiler	<input type="checkbox"/>

* Mögliche Module

3er Modul

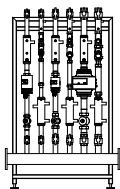

2er Modul

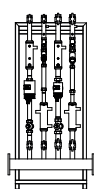

1er Modul

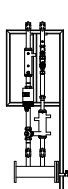

Wenn die Modulgröße nicht angegeben wird, entscheidet das Werk über die Aufteilung in Module.

Anfrageformular

Anwendung.

Anlagenhydraulik

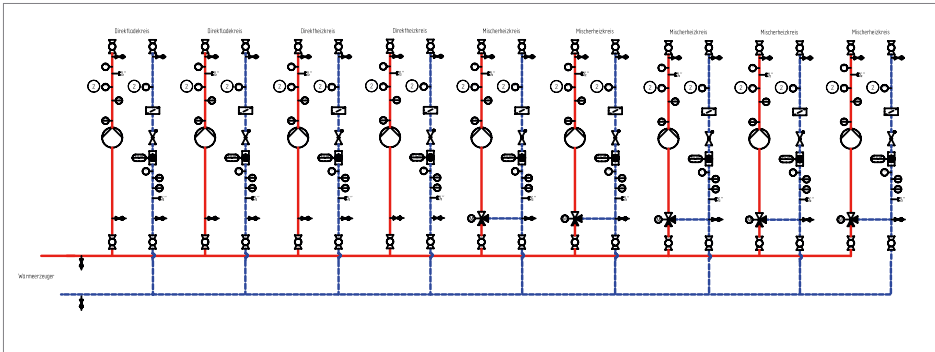

Ausgefülltes Anfrageformular

Formular

Objektadresse _____
 Kunde _____
 Referenz _____ Außendienst _____ Datum _____

Heizkreise und Einspeisung

Heizkreis Anzahl in Standarddesign	Direktladeheizkreis DLK		Direktheizkreis DHK		Mischerheizkreis MHK					Mischerheizkreis dB (direkte Beimischung) MHK dB					Einspeisung	
Basis	<input type="checkbox"/>	<input type="checkbox"/>	<input type="checkbox"/>	<input type="checkbox"/>	<input type="checkbox"/>	<input type="checkbox"/>	<input type="checkbox"/>	<input type="checkbox"/>	<input type="checkbox"/>	<input type="checkbox"/>	<input type="checkbox"/>	<input type="checkbox"/>	<input type="checkbox"/>	<input type="checkbox"/>	<input type="checkbox"/>	
Comfort	<input type="checkbox"/>	<input type="checkbox"/>	<input type="checkbox"/>	<input type="checkbox"/>	<input type="checkbox"/>	<input type="checkbox"/>	<input type="checkbox"/>	<input type="checkbox"/>	<input type="checkbox"/>	<input type="checkbox"/>	<input type="checkbox"/>	<input type="checkbox"/>	<input type="checkbox"/>	<input type="checkbox"/>	<input checked="" type="checkbox"/>	
Premium	<input checked="" type="checkbox"/>	<input checked="" type="checkbox"/>	<input checked="" type="checkbox"/>	<input checked="" type="checkbox"/>	<input checked="" type="checkbox"/>	<input checked="" type="checkbox"/>	<input checked="" type="checkbox"/>	<input checked="" type="checkbox"/>	<input checked="" type="checkbox"/>	<input type="checkbox"/>	<input type="checkbox"/>	<input type="checkbox"/>	<input type="checkbox"/>	<input type="checkbox"/>	<input type="checkbox"/>	
Heizkreis	1	2	1	2	1	2	3	4	5	1	2	3	4	5		
Heizung																
• Radiator <input checked="" type="checkbox"/> <input checked="" type="checkbox"/> <input checked="" type="checkbox"/> <input checked="" type="checkbox"/> <input checked="" type="checkbox"/>																
• Fußbodenheizung <input type="checkbox"/> <input type="checkbox"/> <input type="checkbox"/> <input type="checkbox"/> <input type="checkbox"/>																
Leistung																
•	kW	25	25	50	30	40	70	50	40	45	375
Temperatur Heizkreis																
• Vorlauf	°C	70	70	70	70	60	60	60	60	60	70
• Rücklauf	°C	50	50	50	50	45	45	45	45	45	45
Pumpe Heizkreis																
• Druckverlust Hausanlage *	mbar	200	200	350	250	320	380	250	200	150	
Wärmezähler ** (nur Premium)																
• Q _p	m³/h	1.5	1.5	2.5	1.5	2.5	3.5	3.5	2.5	2.5	
• 230 V		<input checked="" type="checkbox"/>	<input checked="" type="checkbox"/>	<input checked="" type="checkbox"/>	<input checked="" type="checkbox"/>	<input checked="" type="checkbox"/>	<input checked="" type="checkbox"/>	<input checked="" type="checkbox"/>	<input checked="" type="checkbox"/>	<input checked="" type="checkbox"/>	<input type="checkbox"/>	<input type="checkbox"/>	<input type="checkbox"/>	<input type="checkbox"/>	<input type="checkbox"/>	<input type="checkbox"/>
• Batterie		<input type="checkbox"/>	<input type="checkbox"/>	<input type="checkbox"/>	<input type="checkbox"/>	<input type="checkbox"/>	<input type="checkbox"/>	<input type="checkbox"/>	<input type="checkbox"/>	<input type="checkbox"/>	<input type="checkbox"/>	<input type="checkbox"/>	<input type="checkbox"/>	<input type="checkbox"/>	<input type="checkbox"/>	<input type="checkbox"/>

* Sind keine Werte eingetragen, werden folgenden Defaultwerte verwendet:
 - Radiatorenheizung: 300 mbar
 - Fußbodenheizung 400 mbar
 - Zähler verbaut



Aufbau Heizungsverteiler YADO|SHARE



Heizkreise

Bitte Art und die Nummer des Heizkreises an der entsprechenden Position eintragen, z.B.

DHK	DHK	MHK	MHK dB
1	1	2	1

Reihenfolge der Heizkreise wird bei Auftrag definiert.



Einspeisung

Anschluss

seitlich



oben



Position

links

rechts



Aufteilung in Module *

Position Eckmodule

Regelung

YADO MATIX (Standard)	<input type="checkbox"/>
Trovis 55	<input type="checkbox"/>
TopTronic® E	<input checked="" type="checkbox"/>

Schaltschrank

• ja / nein /

Verdrahtung

• ja / nein /

Dämmung

• EPP 50 % (Standard)	<input type="checkbox"/>
• EPP 100 %	<input checked="" type="checkbox"/>
• ohne	<input type="checkbox"/>

Lieferung

• geteilte Anlieferung (Module)	<input checked="" type="checkbox"/>
• kompletter Verteiler	<input type="checkbox"/>

* Mögliche Module

3er Modul

2er Modul

1er Modul

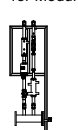
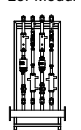

Stand 04-2021

Gelieferter YADO|SHARE Verteiler

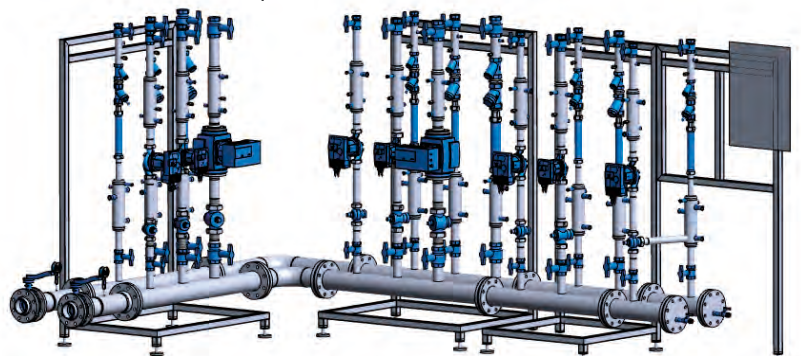

Wenn die Mo
angegeben w
Werk über di

Technische Fakten

Auswahl und Abmessungen.

YADO|SHARE Verteiler

Volumenstrom-Nennweite- ΔT -Leistung bei max. 0,65 m/s

	Volumenstrom V [m ³ /h]	Verteiler DN	max. Leistung bei ΔT 15K [kW]	ΔT 20K [kW]	ΔT 25K [kW]	ΔT 30K [kW]	ΔT 40K [kW]
Standard	1,49	25	25,8	34,5	43,1	51,7	68,9
	2,54	32	44,0	58,7	73,4	88,1	117,5
	3,41	40	59,1	78,8	98,6	118,3	157,7
	5,46	50	94,7	126,2	157,8	189,4	252,5
	9,08	65	157,5	209,9	262,4	314,9	419,9
	12,51	80	216,9	289,2	361,6	433,9	578,5
	21,08	100	365,5	487,4	609,2	731,1	974,8
Konfigurierbar (geplant)	31,88	125	552,8	737,1	921,4	1'105,7	1'474,2
	46,64	150	808,8	1'078,4	1'348,0	1'617,6	2'156,8
	78,37	200	1'359,0	1'812,0	2'265,0	2'718,0	3'624,0
	124,62	250	2'161,0	2'881,4	3'601,7	4'322,1	5'762,8
	176,27	300	3'056,7	4'075,6	5'094,5	6'113,4	8'151,2
	214,21	350	3'714,6	4'952,8	6'191,0	7'429,2	9'905,7
	277,82	400	4'817,7	6'423,6	8'029,5	9'635,4	12'847,2

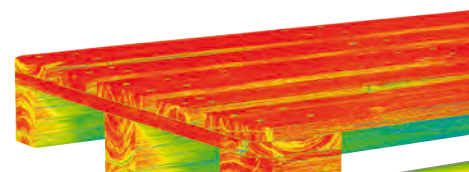
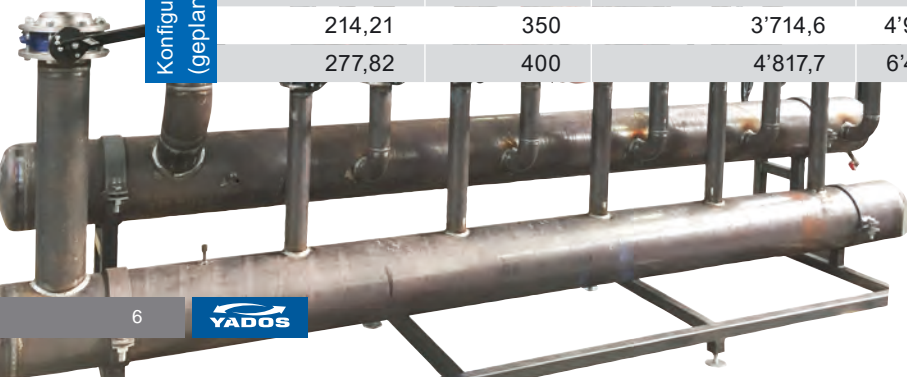

Max. Anzahl Heizkreise bei Standarddesign

bei Einspeisung-Verteiler-Sammler....

DN 100

Heizkreis	DN 25	DN 32	DN 40	DN 50
Max. Anzahl Heizkreise	10 *	8 *	6 *	4 *

DN 150

Heizkreis	DN 25	DN 32	DN 40	DN 50
Max. Anzahl Heizkreise	20 *	16 *	12 *	8 *

* Abhängig vom Erzeugervolumenstrom

YADO|SHARE HeizkreiseVolumenstrom-Nennweite- ΔT -Leistung bei max. 1,3 m/s

	Volumenstrom V [m ³ /h]	Verteiler DN	max.Leistung bei ΔT 7K [kW]	ΔT 10K [kW]	ΔT 15K [kW]	ΔT 20K [kW]	ΔT 25K [kW]
Standard	1,35	20	10,9	15,6	23,4	31,2	39,0
	2,63	25	21,0	30,0	46,0	61,0	76,0
	5,09	32	41,0	59,0	88,0	118,0	147,0
	6,83	40	55,0	79,0	118,0	158,0	197,0
	10,92	50	88,0	126,0	189,0	252,0	316,0
Konfigurierbar (geplant)	18,17	65	147,0	210,0	315,0	420,0	525,0
	25,02	80	202,0	289,0	434,0	578,0	723,0
	42,16	100	341,0	487,0	731,0	975,0	1'218,0
	63,75	125	516,0	737,0	1'105,0	1'474,0	1'842,0
	93,28	150	755,0	1'078,0	1'618,0	2'157,0	2'696,0
	153,74	200	1'244,0	1'777,0	2'666,0	3'555,0	4'443,0
	249,24	250	2'017,0	2'881,0	4'322,0	5'763,0	7'203,0

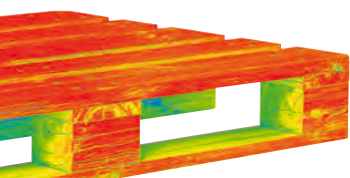

Abmessungen Standarddesign.



Verteiler/
Sammler
DN 100
DN 150

Einspeisung
links

Regelung (optional)
links

3er Modul

2er Modul

seitlich

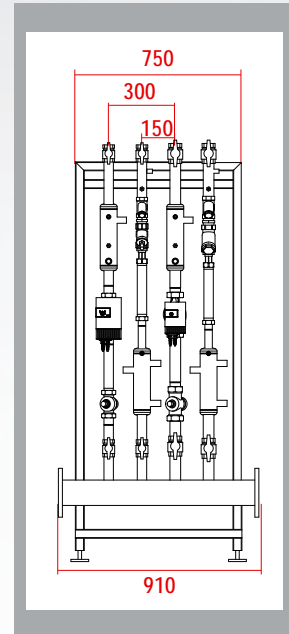
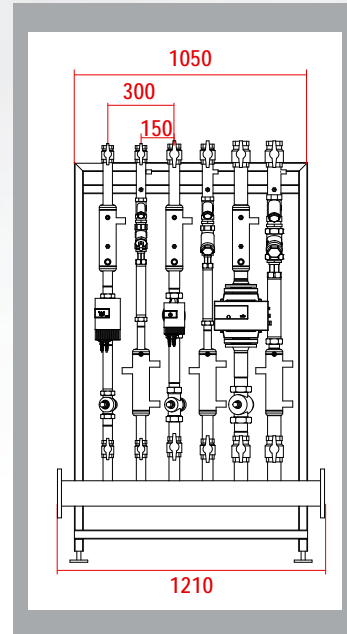
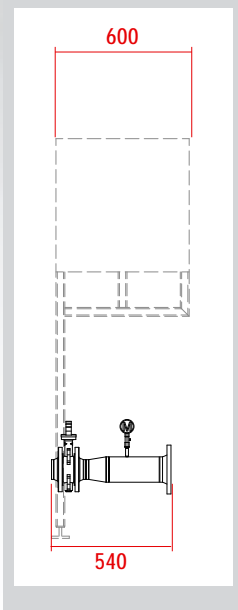

oben

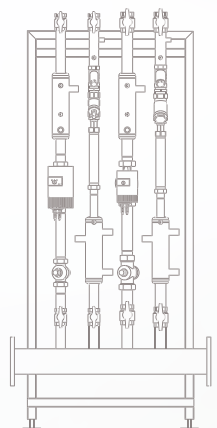
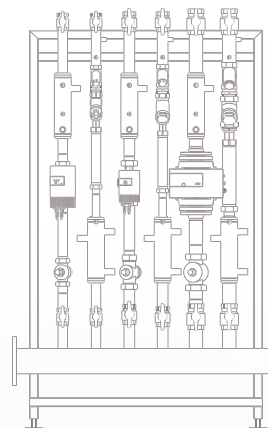
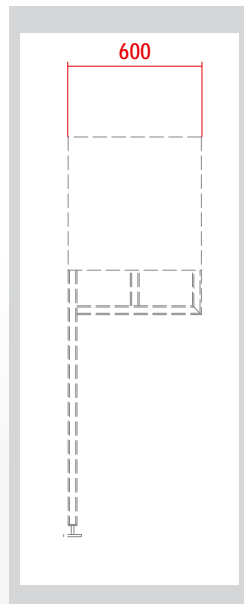
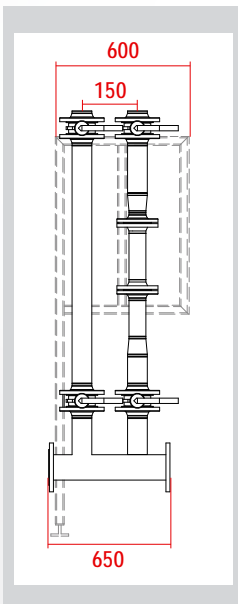

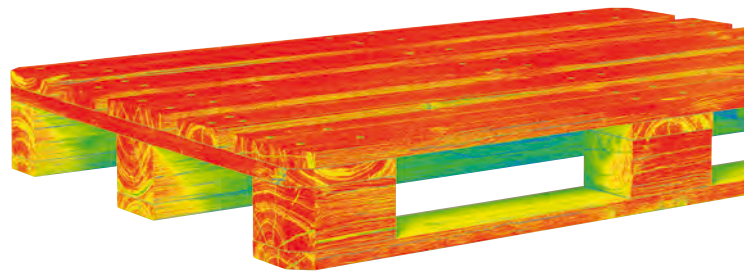

Die Module werden steckerfertig verdrahtet geliefert.

1er Modul

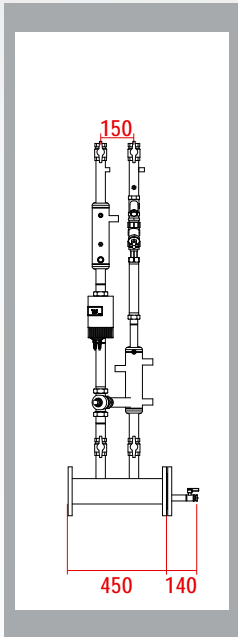

Einspeisung rechts

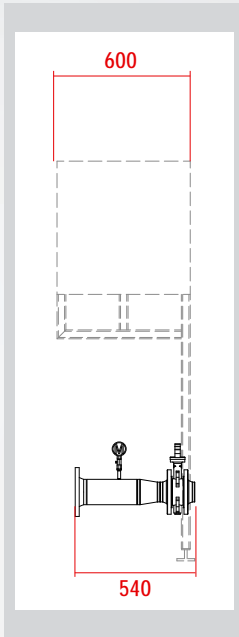

Regelung (optional) rechts

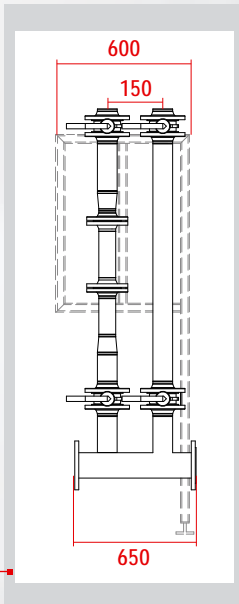
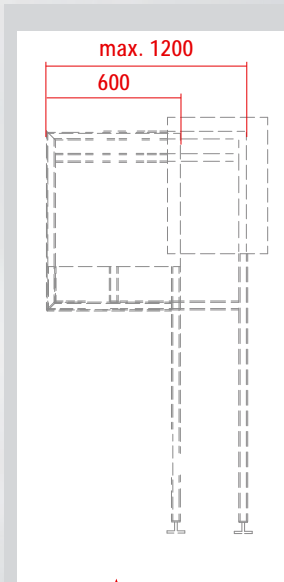

Verteiler/ Sammler

DN 100

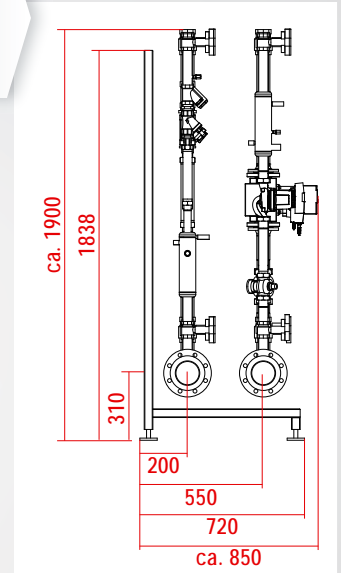

Verteiler/ Sammler

DN 150

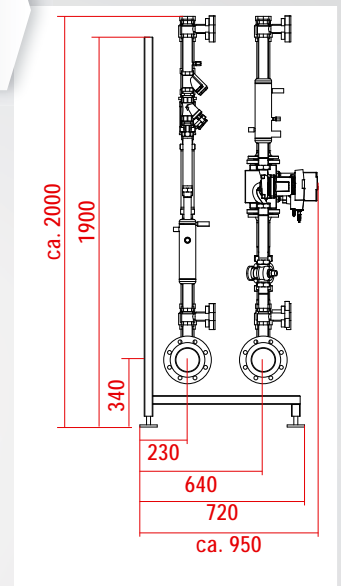

Auftragsabwicklung

Tools und Formulare.

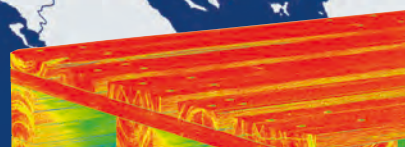

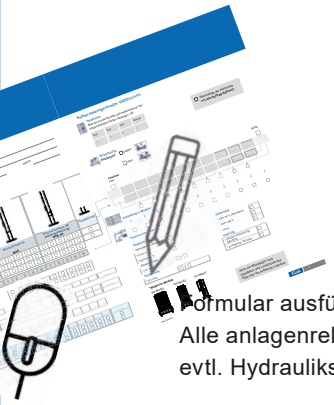

Formular ausfüllen (analog/digital)
Alle anlagenrelevanten Angaben,
evtl. Hydraulikschema beifügen

Angebotsanfrage

versenden per Mail



angebot@yados.de
Feinplanung nach Anlagenangaben

Angebot
mit R&I-Fließschema und
Leistungsbeschreibung



Bestellung



auftrag@yados.de

Auftragsbestätigung
Auftragsbestätigung mit technischen Vorgaben

Lieferung
Lieferung 3 Wochen ab Werk
(exkl. Route, nach Klärung technischer Vorgaben)



Rundum-Service

- Lieferung auf Baustelle oder in das Lager
- Produktdokumentation inkl. Ersatzteilliste
- Bei Bedarf Inbetriebnahme durch YADOS
- Bei Bedarf Wartung durch YADOS

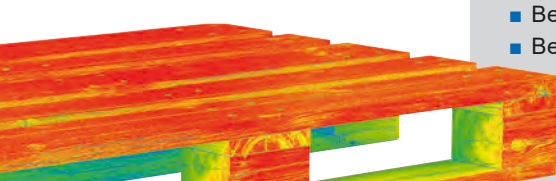

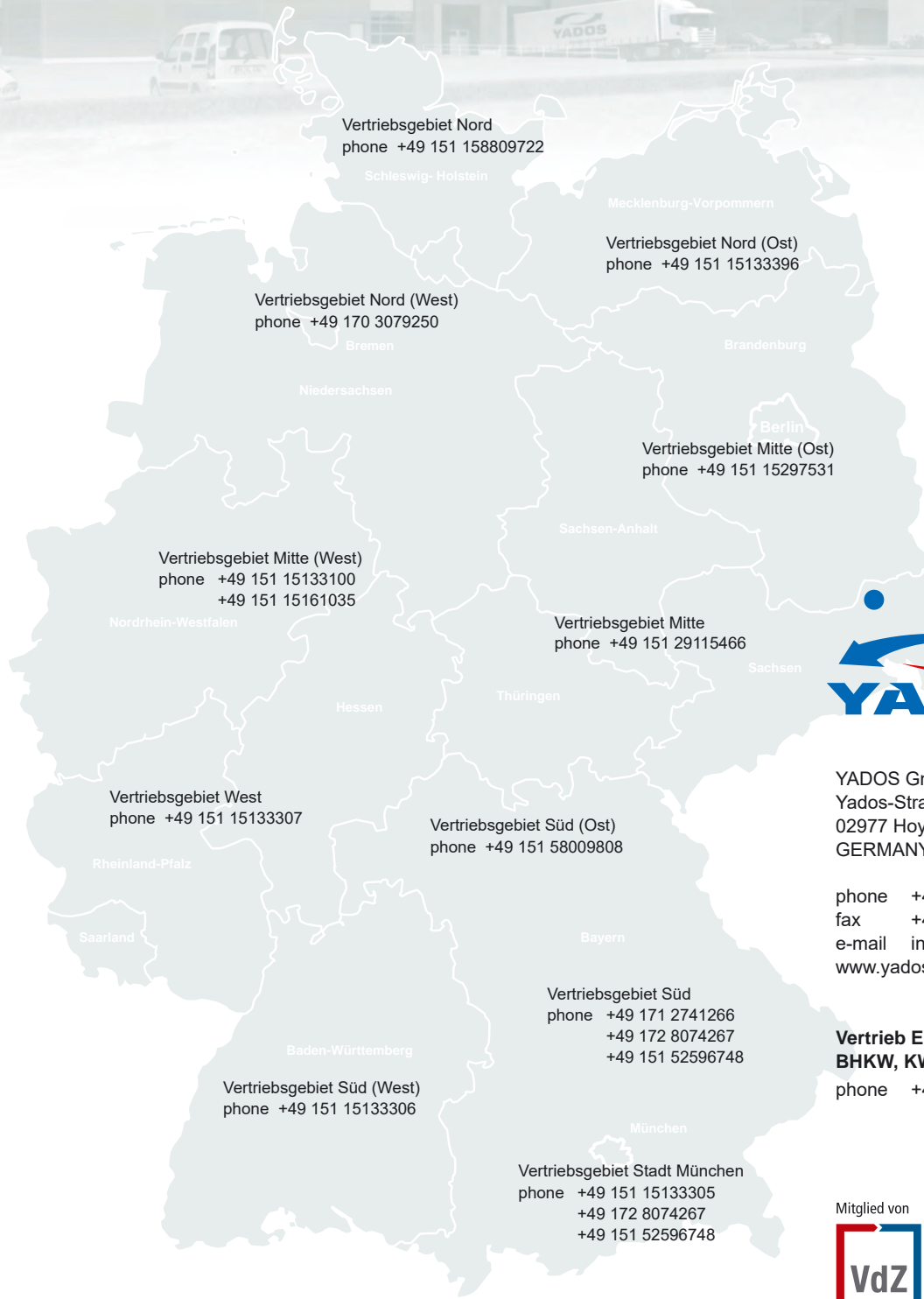

YADOS GmbH
 Yados-Straße 1
 02977 Hoyerswerda
 GERMANY

phone +49 3571 20932-0
 fax +49 3571 20932-999
 e-mail info@yados.de
 www.yados.de

**Vertrieb Energiezentralen,
 BHKW, KWKK-Systemlösungen**
 phone +49 151 15144302 (bundesweit)



Fotos und Produktzeichnungen beinhalten auch Sonderausstattungen. Irrtum und technische Änderungen vorbehalten.
 Texte, Tabellen und grafische Darstellungen dienen ausschließlich dem besseren Verständnis. Sie sind keine Grundlage für Planungen.
 Nachdruck oder Vervielfältigung, auch auszugsweise nur mit Genehmigung der YADOS GmbH, 02977 Hoyerswerda, GERMANY.

Ausgabe 03-2021